

5 Gallon Batch & Process Tank

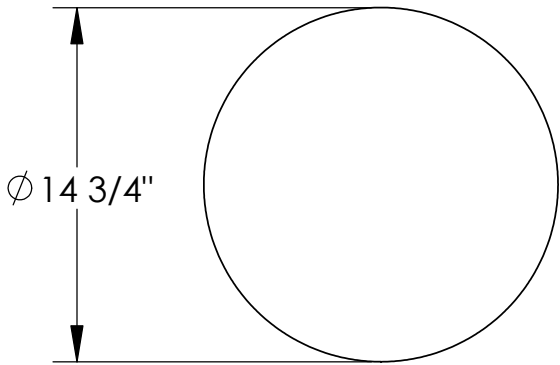

Weight: 5 lbs
 Color: Translucent White
 Wall Thickness: 3/16"

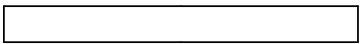
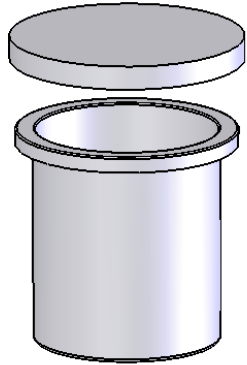
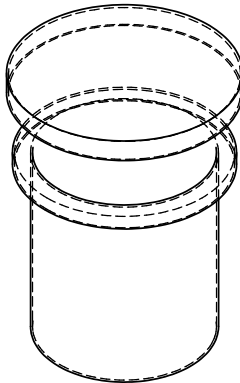

Fill Lines

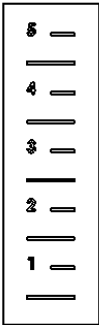
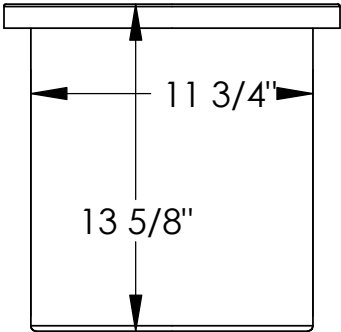

Optional Spigot

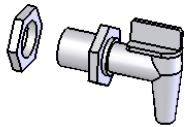

PROPRIETARY AND CONFIDENTIAL

The information contained in this drawing is the sole property of DIXIE POLY DRUM CORP. Any reproduction in part or as a whole without the written permission of DIXIE POLY DRUM CORP. is prohibited.

All Dimensions Are In Inches

MATERIAL
 L.L.D. Polyethylene
 FINISH
 Smooth

Approval			DIXIE POLY DRUM CORP.	
Dept.	NAME	DATE	TITLE:	
			5 gallon process tank	
			SIZE	DWG. NO.
			A	REV
			ANDREW SEARLES	SHEET 1 OF 1